

# GP GRIP LITE BY GPCA

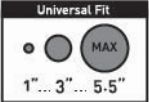

## GET A GRIP

Thank you for choosing the authentic GP-Grip LITE universally designed for 1-5.5" diameter roll bar including any Jeep Wrangler models, 4X4, ATV roll bars. Our unique solid-built handle are sophisticated detailed corresponding to the car design elements. They will become one of your highlight pieces on your loved car. With quick installation, you will soon experience a solid and sturdy grip for all your rides on/ off road, or simply getting in/ out of the vehicle.

Solid fiber reinforced construction, amazing 250 lbs workload. no more swinging back-and-forth. With the flip-away handle, you can enjoy a full window view and never bump your head when getting in and out or checking your tire placement. \*MOLLE strap allows mounting anything you need including the GPCA built-to-last Utility sunglasses case.

**What is included in the package \*check your purchased model \*Illustrations may be slightly different than actual product**

### GP-GRIP LITE



### GP-GRIP LITE + UTILITY CASE

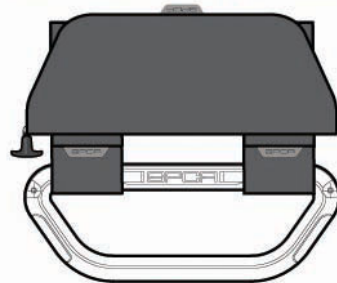

### GP-BACK-GRIP LITE PAIR

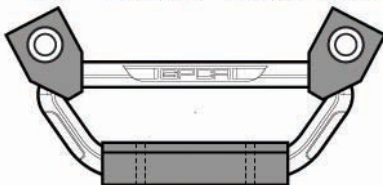

Check your model. Please contact us if you have any installation questions or missing parts. [HELLO@GPCA.US](mailto:HELLO@GPCA.US)

**TRULY MADE FOR ADVENTURIST  
DESIGNED IN USA** 

**WWW.GPCA.US**

Visit us. Shop California Authentic Products

Join our 50K followers

#GPCAofficial

**ADVENTURE NEVER ENDS**



\* Jeep, Wrangler, Rubicon, unlimited, JKU are registered trademarks of FCA (Fiat Chrysler Automobiles). GPCA Products (Touching design LLC), has no affiliation with FCA. Throughout this website and catalog the terms Jeep, Wrangler, MOPAR®, & Rubicon are used for identification purposes only. It is not implied that any part listed is a product of, or approved by Fiat Chrysler Automobiles. We just love Jeeps.

## GP-Grip LITE Instructions

watch video [gpc.us/installation](http://gpc.us/installation)

**Step 1** Mount the handle to the strap end with the Velcro loop

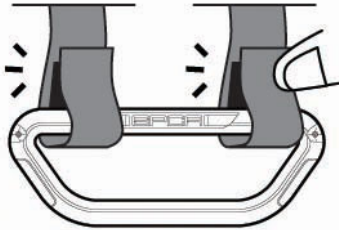

**Step 2** Wrap the straps through the handle and mount it to the roll bar

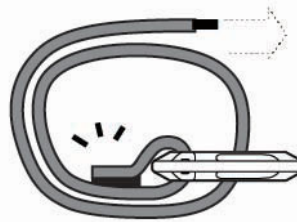

Adjust according to your roll bar diameter

**NOTE** GP-Grip adjusts to fit 1"-5.5" diameter roll bar or anything you need a handle to grab. Be creative!

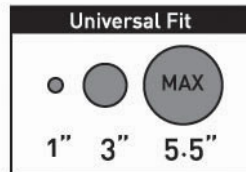

**Step 3** Now flip the handle flat and then pull to tighten the straps for best foldability. After the adjustment, guide the straps through the back loops of the MOLLE strap, pull tight and press the Velcro area.

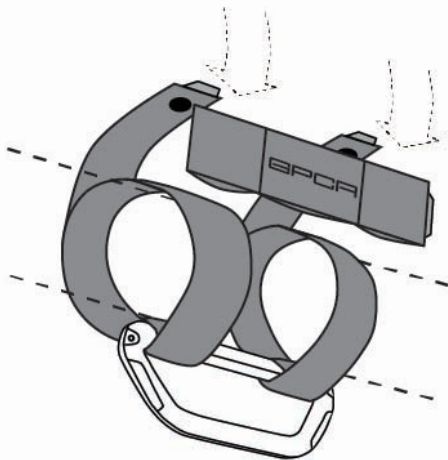

2. TIGHTEN

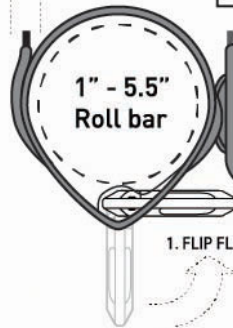

GPCA Utility Uase can be mounted to the MOLLE strap (Optional)



1. FLIP FLAT FIRST

**NOTE** Flip the handle flat and tighten the strap periodically to tight-fit the folded grab handle. These handles are built with outdoor-grade materials. Wipe clean occasionally for a long-lasting use.

## GP-Back-Grip Instructions

watch video [gpc.us/installation](http://gpc.us/installation)

**Step 1** Make sure the extended end under the top ring is between the headrest bar and the metal handle to avoid metal scratching

**Step 2** Plug the headrest poles through the holes

